



2021

Instruction Manual

English



CC21 trivida wheel, carbon
PT20 trivida wheel, plastic



P+L Innovations GmbH

GA-E-tw20-E

2023-02-27

Contents

Introduction	2
Company and brand	2
List of models	2
Use & safety notices	3
1. Indications	4
2. Goods acceptance	4
3. Product description	5
4. Assembly on wheelchair	6
5. Handling the trivida wheels	7
a. Preparing for a transfer	7
b. Fold away clothes guard and armrest	7
c. Opening the segment clamp	7
d. Removing and stowing the segment	7
e. Reinserting the segment	7
f. Closing the segment clamp	7
6. Care	8
7. Maintenance & reuse	8
8. Disposal/Recycling	8
9. Troubleshooting	8
10. Data plate	9
11. Service life and safety	9
12. Guarantee	9
13. Technical data	10
14. Warranty certificate & service entries	11

Introduction

Dear Customer and User of the trivida wheel,

We are delighted that we are able to help you with our new product. Our aim is to support you to the best of our ability. We can only achieve this when we know your needs and you know how our medical aid works. Therefore, we welcome all personal and general feedback from our customers. Please do not hesitate to contact us using our contact details.

In return, with this user guide we want to show you how to optimally use and care for our product and avoid risks. Please read through the user guide and contact your approved dealer or us directly if anything is unclear or if you have any questions.



Please read through the user guide before using the trivida wheels!



For users who are visually impaired, PDF files of this user guide are available on our website, which can be read in a reasonably sufficient size or played back with the use of corresponding technical devices.

We are interested in the further development of our medical aids for your comfort, maximum freedom and independence. Therefore, there may be changes to our products which are not reflected in the illustrations in this user guide.



Different equipment features do not give rise to any claims for your delivered product.

Like every technical product, your trivida wheel requires maintenance, service and hopefully only spare parts in exceptional cases. This user guide contains information on caring for your product. You can perform the service yourself or arrange to have the service carried out by an authorised dealer or ourselves. Spare parts can also be purchased from the dealer or ourselves. We are happy to answer any questions that you may have. You can reach us during normal office hours at:

Ph.: **+49 7633 920 3939**

E-mail: **service@trivida-info.com**

Service address: **Am Krozinger Weg 11
79189 Bad Krozingen
Germany**

GA-E-tw20-E

Company and brand

P+L Innovations GmbH founded the trivida brand in order to develop and provide new products for you in the area of medical aids.



We are committed to quality and obtain certification according to ISO 13485. Our products meet the requirements of the European **Medical Device Regulation (MDR) (EU) 2017/745** and have a CE certificate.



Our Basic **UDI-DI** in **EUDAMED** is:

426074072CHAP202074

We try to work sustainably and protect resources through the selection of our materials, suppliers and manufacturing processes. Our products are tested by a state testing laboratory.



Please note that our products are supplied for appropriate recycling.

List of models

This user guide is valid for the following models:

- **CC21 – trivida wheel in carbon**
- **PT20 – trivida wheel in plastic**

Date of last update: 2023-01-27

The user guide is still available following model changes.

Use & safety notices

The trivida wheel is only to be used on standard wheelchairs for users who are unable to walk or whose locomotor system is severely restricted. It is designed for a maximum weight.



This results in a maximum overall weight for user and wheelchair of 150 kg.

The trivida wheel is designed for indoor and outdoor use. It should facilitate the transfer into and out of the wheelchair and can be used for simplifying the transport of the wheelchair with its easy and quick disassembly.



A warranty is only provided if the trivida wheel is used for the intended purpose.

The wheels on the wheelchair are not designed for transporting its user in the wheelchair in a car, particularly not when disassembled.



Always use the option of a fixed seat and seat belt in vehicles. It's for your safety!

The trivida wheel is not designed for use on difficult terrain and in extremely rough surroundings. This applies in particular to mountains and very dirty or sandy environments. There are other accessory wheels available for your wheelchair for this purpose. Please treat the wheels with care. Heavy dirt can have a negative impact on the function and durability of the split wheels.



Clean dirt and sand off all movable components in order to prevent premature wear and functional impairment.

Wheelchairs are generally only intended for transporting people. Maximum weight limits apply to the wheelchairs and the trivida wheels. Misuse and overloading the wheels may result in hazards. Use by children also creates additional risks. There will be suitable wheels available in the future for people under 14 years of age.



Only use the wheels for the intended purpose and if you are 14 years or older.

Depending on the wheelchair model, weight shifts when transferring into and out of the wheelchair may cause the wheelchair to tip. Therefore, please test the transfer into and out of the wheelchair with the trivida wheels first and where possible in the presence of an assistant. Always secure both parking brakes before loosening the wheel segments. The brakes must not press down onto the wheel segment to be loosened.



The parking brakes must be secured before loosening the segments and when the trivida wheels are disassembled.

The brake levers on the wheel are not intended for braking during the journey. The brake levers would reach between the tyre segments, brake the wheelchair suddenly or cause the wheelchair to overturn. This may result in injuries. The wheels may incur damage.



Never use the parking brakes during the journey to brake the wheelchair!

There is a risk of fingers getting caught when opening or closing the eccentric grips, as well as when removing or inserting the wheel segments. Therefore, please proceed with caution and do not act frantically or with great force.



There is a risk of crushing or pinching during disassembly and assembly if handled carelessly. Be careful!

If your wheelchair is exposed to intensive sunlight for prolonged periods, dark parts may become hot.



Make sure that your wheelchair is not exposed to strong sunlight and heat. Touch heated parts very carefully!

If parts snap off or get lost due to improper handling of the wheels, the wheels may no longer be used.



Arrange to have the trivida wheels serviced by your dealer or us in the event of loss of or defects with parts.

The trivida wheel has not been crash tested in a car.



It therefore does not comply with AS/NZS 3696.19. Please attach the attached sticker to the wheelchair so that it is clearly visible.

**NOT AS/NZS 3696.19
COMPLIANT**



Contraindications

Wheelchairs are generally only intended for the transport of people. Maximum weight (see above) and speed limits apply to wheelchairs and trivida wheels. Speeds of more than 6 km/h are not intended without additional accessories (trivida clip). Use by children under the age of 14 or people with cognitive disabilities is dangerous. If you have reduced control in your arms, it is recommended to use solid carbon wheels only. This minimizes the risk of jamming. Make sure the wheels are safe to use as instructed. Use the wheels only for the intended purpose and from the age of 14. Be aware of dangers from limited arm control, cognitive deficits and improper speed.

1. Indications

The use of the trivida wheel is recommended for the following indications:

- ☞ trivida wheels facilitate the transfer into and out of wheelchairs with drive wheels at the side. They are designed to assist independent and assisted wheelchair users.
- ☞ trivida wheels support independence in day-to-day living and facilitate participation in social interactions. In many cases they offer more dignity and safeguard privacy.
- ☞ In the case of transfers with external support the wheel relieves the assisting persons. The lateral transfer facilitates the support and relieves the musculoskeletal system of the assistant.
- ☞ Reasons for the use of a wheelchair include inability to walk or severely restricted walking ability, irrespective of their cause.
- ☞ trivida wheels can be used indoors and outdoors, but are not suitable for use on off-road areas, on the beach or in water.
- ☞ trivida wheels can be used in push mode and for self-drivers.
- ☞ Please note: wheel drives on the axles of the trivida wheel to support wheelchair users are not yet available. However, supporting drives that are attached to the wheelchair can be used.
- ⚠ A maximum speed of 6 km/h should not be exceeded.

2. Goods acceptance

Our trivida wheels are tested according to strict criteria during production and are subject to a final inspection after assembly. This allows us to ensure that your trivida wheels are fault-free when they leave our factory. The wheels are packed in special, climate-neutral boxes in order to prevent damage during transportation. However, incidents may still happen. Therefore:

- ☞ Please check your delivery on receipt – if possible, in the presence of the carrier and have the damage to the packaging confirmed or report it immediately to the shipping company or us. Check the wheel thoroughly for defects in the case of damage. If there is no visible damage to the

wheels, the trivida wheels can be used. They have a very sturdy design.

Box and seal should not be damaged.



Complete packaged content: Two assembled trivida wheels and two axles with assembly bushes

- ☞ The box should be stored for subsequent transport of the trivida wheels.
- ☞ Consider environmentally friendly recycling options for the disposal.



3. Product description

trivida wheel, front

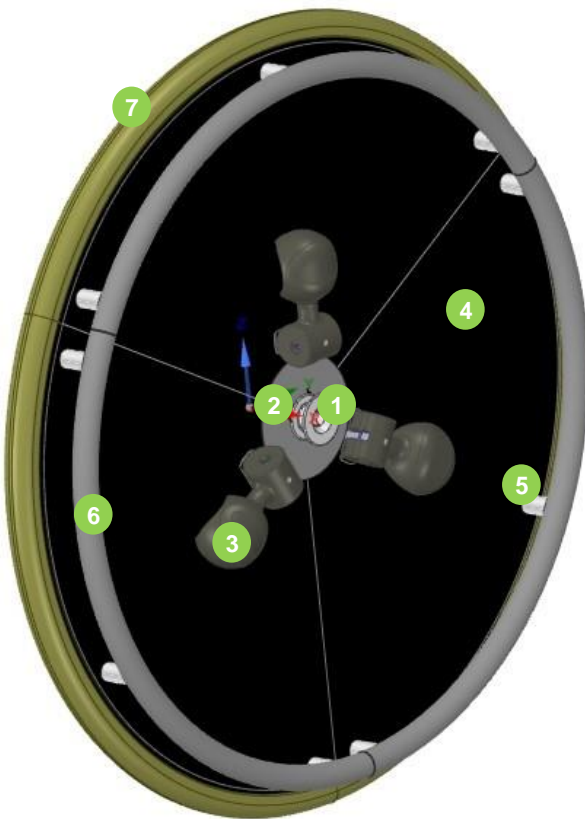

trivida wheel, back

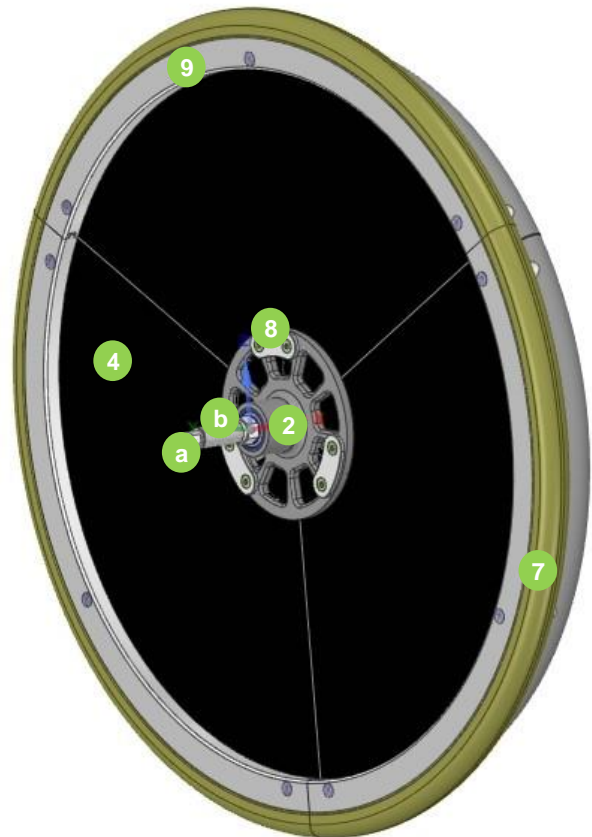

- | | |
|---|---|
| 1 Front cover (aluminium) | 2 Central segment clamp (aluminium) |
| 2 Central segment clamp (aluminium) | 4 Wheel segment (carbon or plastic PBT) |
| 3 Excenter arm (plastic PBT) | 7 Tyre segment (plastic PUR) |
| 4 Wheel segment (carbon or plastic PBT) | 8 Rear panel (aluminium) |
| 5 Spacer sleeve, handrim (aluminium) | 9 Tyre clamp segment (aluminium) |
| 6 Handrim (aluminium) | a Quick-release axle (steel) |
| 7 Tyre segment (plastic PUR) | b Assembly bush (steel) |
| | c Mounting nut - not shown (steel) |

Note: The tyre clamp segment (9) is only used for the carbon wheel. This component is omitted with the two-part sandwich design for the plastic wheel. Both plastic parts are made from the same material and are screwed tightly.



We reserve the right to make changes to the product in the course of our development and innovation. Deviations from the illustration do not constitute any basis for claims. Carbon and plastic version of the trivida wheel differ in items 4 and 9. No additional tyre clamp is required with the two-part structure of the plastic wheel segments.

4. Assembly on wheelchair

Before you order trivida wheels, you should check which quick-release axle system your wheelchair uses. The diameter of the quick-release axle and the length of the assembly bush attached to the wheelchair are decisive. Ideally, you will therefore have no difficulty in simply replacing the existing wheelchair wheels with the trivida wheels.



Nevertheless, before installing your trivida wheels, please check which assembly bush your wheelchair has!

To do this, dismantle the quick-release axles and drive wheels of your wheelchair. Plug the supplied quick-release axles into the socket on the wheelchair. **The axle must not wobble in the socket!** If this is the case, you can attach the trivida wheels to the wheelchair with or without drum brakes. Make sure the axles are fully engaged. The axis should no longer be able to be pulled out as soon as you let go of the push button! The pin at the end of the quick-release axle must disappear completely into the tube.

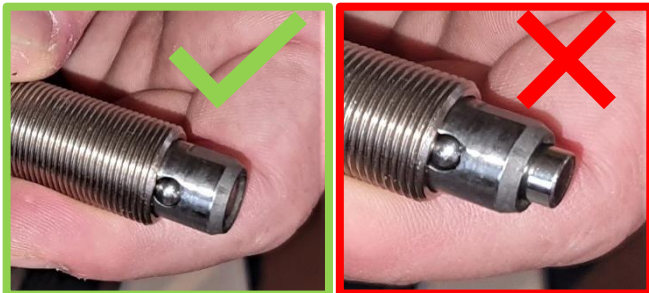

When mounting the wheels, always make sure that the quick-release axle lock is fully engaged.

With drum brakes: If the diameter of the brake calipers does not match the diameter (\varnothing 70 mm) on the central segment clamp, the brake calipers must be replaced. Please contact your authorized dealer or us.



If the length of the assembly bush at the wheelchair is not known to us or is not consistently of the same length, we will send the quick-release axles with loose front caps. You or your authorized dealer can thus adjust the axle length yourself to the existing bush. In this case, we provide the instructions for this with: "Instructions for mounting the quick release axles for CC21 & PT20".

Alternative:

If the diameters and lengths differ, the assembly bushes on the wheelchair can also be exchanged for the supplied bushes. Please contact your authorized dealer or us. Check the user manual for your wheelchair. The bushes supplied are to be mounted with a torque of 30-35 Nm. It may be necessary to adjust the exact position



of the assembly bush with washers. If it is not possible to mount the supplied bushes, contact your authorized dealer or us.

Adjustment of the brake:

After replacing the wheels, note that the parking brakes may have to be adjusted to the new wheel. The brake contact must press on the tyre with the correct force



and completely resting on it. Follow the operating instructions of your wheelchair or ask your dealer.



Only use your wheelchair if you are absolutely sure that both wheels are securely mounted!

5. Handling the trivida wheels



Wheel segments may only be removed when both parking brakes of the wheelchair are securely locked.

Please note that the braking effect of the parking brakes may vary due to different wheel sizes. Before using the trivida wheels for the first time ensure that the brakes of your wheelchair are optimally adapted to the wheel size. Observe all information and instructions from your wheelchair manufacturer with regard to the parking brakes.

a. Preparing for a transfer

Position yourself with your wheelchair beside the area where you want to sit. Ensure that the parking brake is applied on the side of the transfer just below a separating edge of the trivida wheel. Maintain approx. 10 cm distance to the side in order to be able to open the Excenter arm.

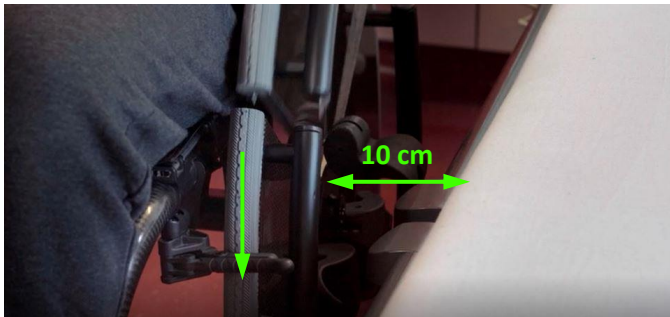

b. Fold away clothes guard and armrest

Armrests and clothes guards must be folded back or removed for the obstacle-free transfer. Many wheelchairs are already prepared for this. Please see the user guide from your wheelchair manufacturer. If your clothes guard and armrest are not flexible, your



medical supply dealer, in most cases, can give you the option of an exchange or a simple retrofit.

c. Opening the segment clamp

Push or pull the ergonomic eccentric quick - release lever out and down until it is fully open. For safety you have to overcome the engagement of the lever. This prevents unintentional opening of the Excenter arm.

d. Removing and stowing the segment

Lift the loosened wheel segment up out of the clamp.



You can now place the wheel segment the other way around with the handrim segment into the handrim of the opposite wheelchair wheel. The segment is safely stowed here and accessible to you at any time.



Be careful when executing the transfer and do not cause the wheelchair to tip by excessive lateral displacement.

e. Reinserting the

segment

As soon as you have sat back into the wheelchair, you can slide the removed segment upright from above into the clamping device with the side guides.

f. Closing the segment clamp



Pull the quick - release lever up. Ensure that it engages and lies flat and parallel to the wheel surface.



If the Excenter arm is not engaged the clamp may open, meaning you may lose a wheel segment. Ensure that all the Excenter arms for your wheels are closed at all times. Pay special attention after strong vibrations and long journeys.

6. Care

Your trivida wheels include movable parts and fits with safety-relevant functions. With adequate care their functionality is maintained for a long time.



Clean the wheelchair and wheels regularly using a soft, damp cloth and a gentle, non-abrasive cleaning agent and ensure that:

- ☞ Your trivida wheels are dried after use in wet conditions.
- ☞ The quick-release axles are lubricated every 3 months with a drop of sewing machine oil.
- ☞ the sliding surfaces between the Excenter arm and the wheel segment are kept smooth-running through a plastic-compatible silicone sliding spray (e.g. from NIGRIN) every 3 months.
- ☞ The fittings between the wheel segments and the segment clamp are dust- and dirt-free.
- ☞ Store the wheels in a dry place at room temperature for long periods of non-use. Intensive sunlight should be avoided. Check the wheels before recommissioning.
- ☞ Sand, seawater or gritting salt should be removed quickly and thoroughly if the wheels have come into contact with these elements.
- ☞ All contact surfaces should be kept hygienically clean. Use an antibacterial and fungicidal disinfectant for the spray disinfection, according to the standards EN 1040, EN 1276 or EN 1650. Pay attention to the manufacturer's instructions for use.

7. Maintenance & reuse

An annual inspection of the trivida wheels by us or your dealer is recommended. If the wheels are passed on to another user, the wheels should undergo a full service before being used again.



Ensure that the applicable hygiene regulations are observed.

- ☞ The preload of the segment clamp and its function must be checked.
- ☞ The tyre segments must be checked for wear (profile depth) and damage.
- ☞ The bearings have lifelong lubrication.
- ☞ The wheel must be disinfected (see **6. Care**).

- ☞ The side tongue and groove locks on the wheel segments must be checked.
- ☞ All wear parts must be checked and if necessary, replaced with original spare parts.
- ☞ The secure position of all parts must be checked.
- ☞ Significant changes to the wheels are only permitted within the framework of the maintenance work in conjunction with a new conformity assessment procedure.
- ☞ If the data plate is damaged or becomes illegible, a new data plate must be requested from P+L Innovations GmbH.

The inspection and all work must be documented and added to the wheel documents (P. 11).

8. Disposal/Recycling

When selecting the materials used for the trivida products we pay attention to safety, sustainability, health and environmental compatibility. So that our commitment is successful, we rely on your cooperation and support. Therefore, please observe the following instructions regarding materials and their disposal, as well as the local circumstances. All parts of the trivida wheels can generally be recycled.

Information on the materials used can be found in chapter 3 "Product descriptions". Our packaging is climate-neutral. The packing bags for the quick-release axles are made from soft polyethylene.

Contact your local waste disposal centre regarding disposal. Your dealer may also accept the wheels and can dispose of these in the proper manner.





9. Troubleshooting



Assembly on wheelchair difficult:

- ☞ The two parking brakes must be open to exchange the wheels.
- ☞ Check whether the axles fit.
- ☞ Keep the assembly bush and quick-release axle running smoothly with some sewing machine oil.



Wheelchair twists in one direction:

-  Rule out that other factors at your wheelchair have caused the problem.
-  Check whether both wheels turn smoothly, and no part is loose or grinds against the wheelchair.
-  Check whether all tyre segments sit firmly in their clamp.

Wheel segments rattle or are loose:

-  Are all Excenter arms firmly closed?
-  If the segments have play, although the Excenter arms are firmly closed, arrange to have them readjusted by a service partner.

Excenter arms do not close or close with difficulty:

-  Are all wheel segments sitting firmly in their intended positions?
-  Are all wheel segments inserted correctly?
-  If the preload of the Excenter arms is pre-set too high, you can arrange to have this readjusted by a service partner.

10. Data plate



The data plate is installed on the hub of the central segment clamp. Details about the model (REF), the serial number (SN) and the date of manufacture can be found on the data plate. The maximum permissible weight and we, as manufacturer, are also specified. A link to the user guide on our website is also contained in the QR code. The barcode contains the serial number.



Please note the information on the data plate.

11. Service life and safety

trivida wheels are designed to be used for at least 5 years. High-quality carbon is able to be used for longer. Before the sales launch both trivida wheel types CC20 and PT20 were successfully tested by a state-appointed testing centre according to the European standards. However, should problems or concerns arise, we will inform you about recalls concerning the affected serial numbers on our website – insofar as you have consented to the storage of your contact details.

12. Guarantee

YOUR STATUTORY RIGHTS ARE NOT AFFECTED BY THIS WARRANTY.

P+L Innovations GmbH grants the following warranties for all trivida wheels:

1. The warranty is subject to the law of the country where the product was purchased.
2. We will repair or replace defective parts due to manufacturing or material errors within 24 months.
3. Please contact us directly to assert your claims with a precise description.
4. We provide a warranty on exchanged parts for the remaining duration of the warranty of the product.
5. You receive a 12-month warranty based on these warranty conditions on original spare parts that you have paid for.
6. The following points do not constitute a basis for a warranty claim:
 - a. Normal wear on the tyres.
 - b. Overloading of the product beyond the permissible limits.
 - c. Damage caused by failure to comply with recommendations in this instruction manual.
 - d. Attachment or use of unauthorised accessories. Only use trivida original parts!
 - e. Damage due to accident or improper use.
 - f. Unauthorised retrofits or repairs.

13. Technical data

Versions	PT20 - Plastic	CC21 - Carbon
Diameter	24" (approx. 600 mm)	24" (approx. 600 mm)
Tyre segments	Solid rubber (PU)	Solid rubber (PU)
Max. permissible camber	3°	3°
Max. load-bearing capacity for two wheels	150 kg	150 kg
Standard quick-release axle supplied	Quick-release axle \varnothing 12 mm or \varnothing 1/2"	
Quick-release axle for 50 mm bush	108 mm for \varnothing 12 mm, 110 mm for \varnothing 1/2", drum brakes 113 mm (\varnothing 12 mm)	
Assembly bush supplied	M16 x 50 mm - for \varnothing 12 mm	M16 x 50 mm - for \varnothing 12 mm
Adaptable to bush lengths	27-72 mm	27-72 mm
Adaptation to other Axles	Please contact us directly	
Max. permissible speed	ca. 6 Km/h	
Segment weight (3 segments)	je 1.030 g	je 830 g
Total weight	3.980 g	3.300 g
Extra Weight Drum Breaks	190 g	
Extra Weight Rubber Coating	210 g	
Design	Spoke wheel, matt surface, black	High-gloss carbon disc, black
Guarantee	24 months	24 months
Certification	CE	CE
Scope of delivery	trivida wheels Quick-release axles, assembly bushes and mounting nuts	trivida wheels Quick-release axles, assembly bushes and mounting nuts

More up-to-date information can be found online at <https://www.trivida.com.au/instruction-manual.pdf>

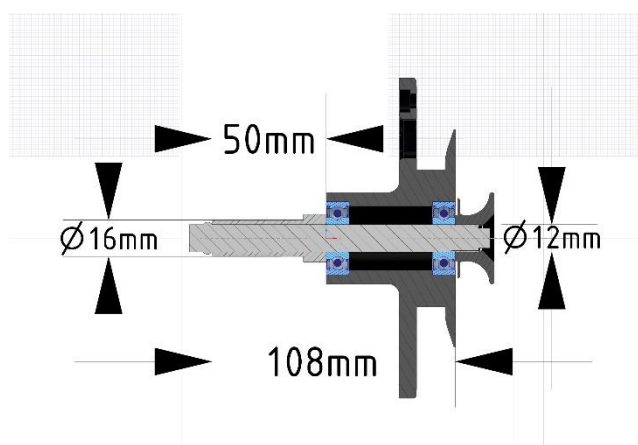

Manufacturer:
P+L Innovations GmbH

Am Krozinger Weg 11
 79189 Bad Krozingen
 Germany

Ph.: +49 7633 920 3939

E-mail: service@trivida-info.com

14. Warranty certificate & service entries

Serial number:	Packed on:
Serial number:	Checked by:
Date: Measures: Service partner:	Date: Measures: Service partner:
Date: Measures: Service partner:	Date: Measures: Service partner:
Date: Measures: Service partner:	Date: Measures: Service partner:
Your personal dealer:	<p>This user guide also serves as a service manual (see Page 8). Should you have any questions or require further details, please contact your authorised medical supply dealer (see left) or us.</p> <p>Ph.: +49 7633 920 4850</p> <p>E-mail: service@trivida-info.com</p>